



ULTRA 3S



ULTRA 5S



ULTRA 7S



ULTRA 9S



ULTRA 18S



Pompe centrifughe multistadio orizzontali. Adatte alla movimentazione di liquidi non carichi; sistemi di pressurizzazione; irrigazione; acque potabili o con glicole in soluzione; trattamento acque; industria alimentare; riscaldamento e condizionamento; sistemi di lavaggio.

Stainless steel multistage horizontal pumps. Pumping of clean non-loaded fluids; pressurizing system; irrigation; drinking and glycol water; water treatment; heating and air conditioning; washing system.

Bombas centrífugas multietapas horizontales. Bombeo de líquidos químicamente y mecánicamente no agresivos; sistemas de presurización; riegos; agua potable o con glycol; tratamientos del agua; industria alimenticia; calefacción y refrigeración; sistemas de lavado.

Vícestepňová horizontální čerpadla z nerezové oceli. Vhodná pro čerpání čistých kapalin; tlakové systémy; zavlažování; pitnou a glykolovou vodu; úpravu vody; vytápění a klimatizace; mycí stanice.

**CARATTERISTICHE COSTRUTTIVE / CONSTRUCTION FEATURES  
CARACTERÍSTICAS CONSTRUCTIVAS / KONSTRUKČNÍ CHARAKTERISTIKY**

<b>Corpo pompa</b> <b>Pump body</b>	acciaio cromo-nichel AISI 304 stainless steel AISI 304
<b>Cuerpo bomba</b> <b>Těleso čerpadla</b>	acero cromo-níquel AISI 304 nerezová ocel AISI 304
<b>Supporto motore</b> <b>Motor bracket</b>	alluminio aluminium
<b>Soporte motor</b> <b>Držák motoru</b>	aluminio hliník
<b>Girante</b> <b>Impeller</b>	acciaio cromo-nichel AISI 304 stainless steel AISI 304
<b>Rodete</b> <b>Oběžné kolo</b>	acero cromo-níquel AISI 304 nerezová ocel AISI 304
<b>Tenuta meccanica</b> <b>Mechanical seal</b>	ceramica-grafite ≤ 6 giranti grafite-carburo di silicio ≥ 7 giranti ceramic-graphite ≤ 6 impellers graphite-silicon carbide ≥ 7 impellers
<b>Sello mecánico</b> <b>Mechanická ucpávka</b>	cerámica-grafito ≤ 6 rodetes grafito-carburo de silicio ≥ 7 rodetes keramika-grafit ≤ 6 oběžných kol grafit-karbid křemíku ≥ 7 oběžných kol
<b>Albero motore</b> <b>Motor shaft</b>	acciaio cromo-nichel AISI 303 stainless steel AISI 303
<b>Eje motor</b> <b>Hřídel motoru</b>	acero cromo-níquel AISI 303 nerezová ocel AISI 303
<b>Temperatura del liquido</b> <b>Liquid temperature</b> <b>Temperatura del liquido</b> <b>Teplota média</b>	-15 ÷ +110 °C
<b>Pressione di esercizio</b> <b>Operating pressure</b> <b>Presión de trabajo</b> <b>Pracovní tlak</b>	max 8,5 bar
<b>MOTORE / MOTOR / MOTOR / MOTOR</b>	
<b>Motore 2 poli a induzione</b> <b>2 pole induction motor</b> <b>Motor de 2 polos a inducción</b> <b>2-pólový indukční motor</b>	3~ 230/400V-50Hz 1~ 230V-50Hz (con termoprotettore fino a 1,85kW with thermal protection up to 1,85 kW con protección térmica hasta 1,85 kW s tepelnou ochranou do 1,85 kW)
<b>Clase di isolamento</b> <b>Insulation class</b> <b>Clase de aislamiento</b> <b>Izolační třída</b>	F
<b>Grado di protezione</b> <b>Protection degree</b> <b>Grado de protección</b> <b>Krytí</b>	IP44

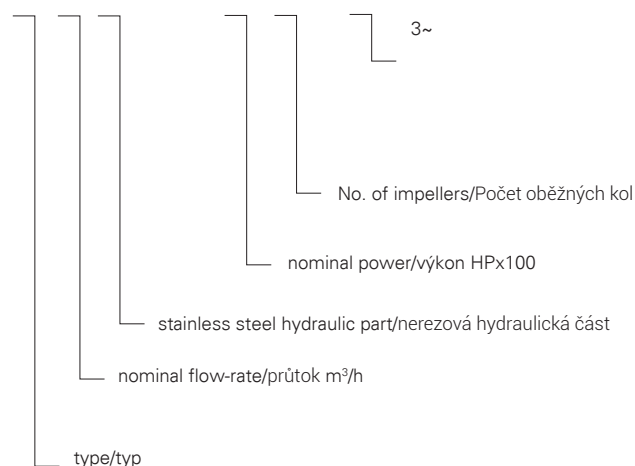
**U 3 S - 120/6 T**

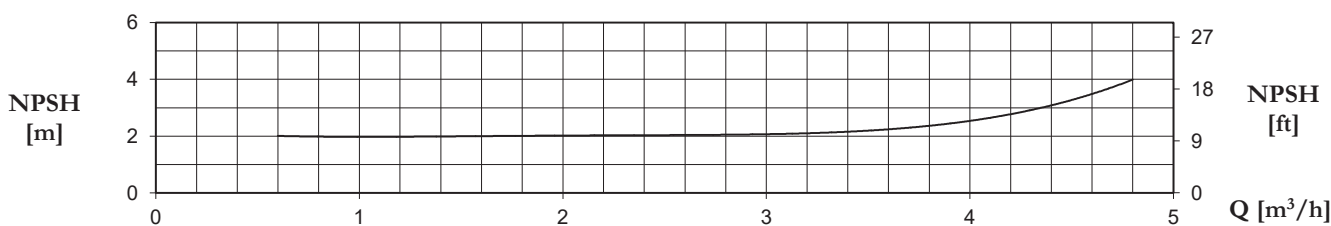
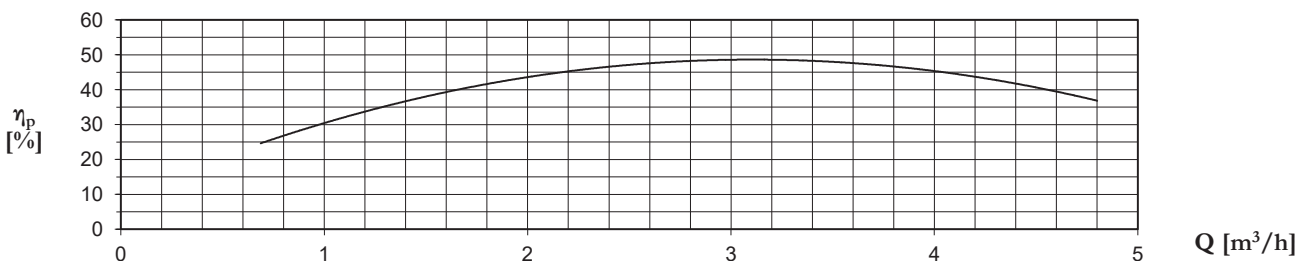
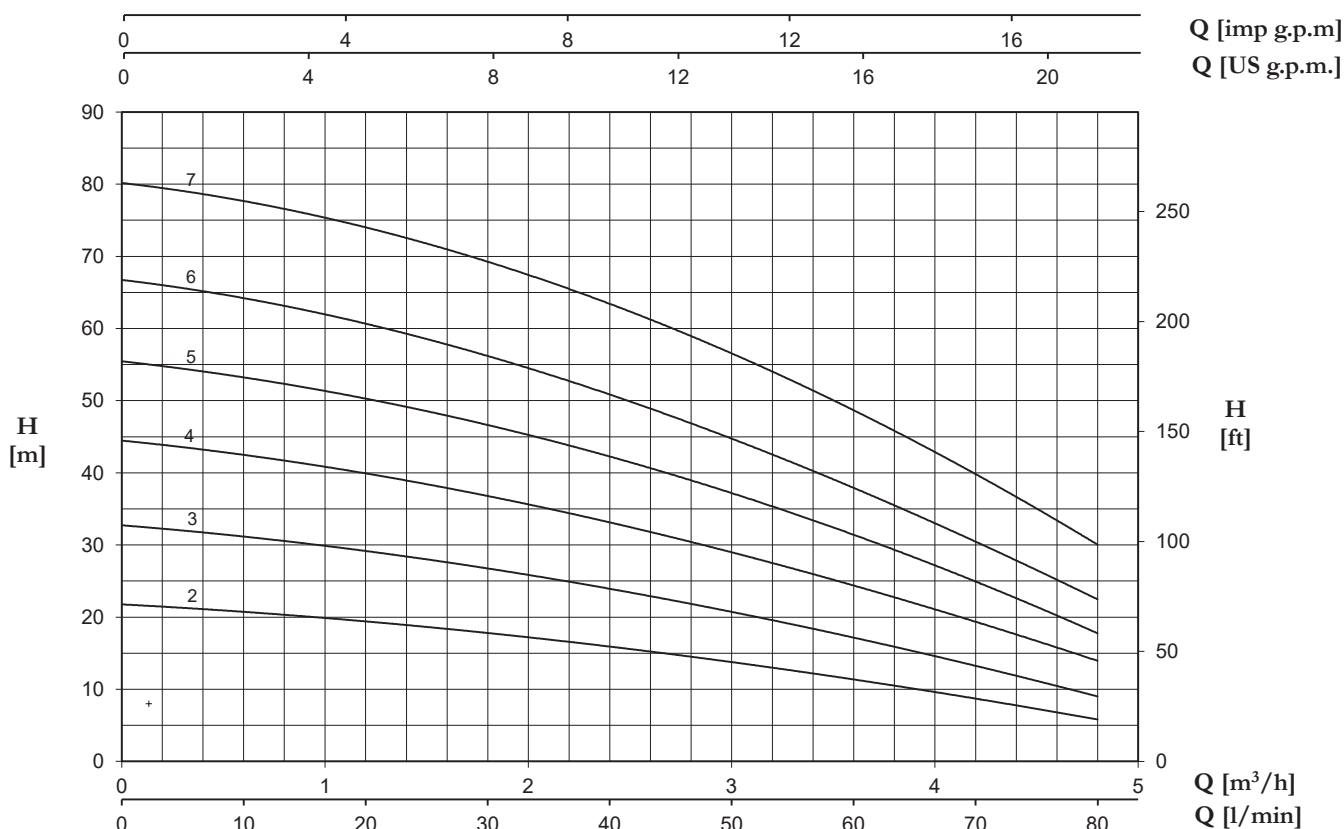

TYPE/TYP		P2		P1 (kW)		PROUD		Q (m³/h - l/min)						
1~	3~	(HP)	(kW)	1~	3~	1~	3~	0	0,6	1,2	1,8	2,4	3,6	4,8
						1x230 V 50 Hz	3x400 V 50 Hz	0	10	20	30	40	60	80
								H (m)						
U 3S-50/2	U 3S-50/2T	0,5	0,37	0,41	0,41	1,8	0,9	21,7	20,9	19,3	17,8	15,9	11,4	5,8
U 3S-70/3	U 3S-70/3 T	0,7	0,51	0,61	0,58	2,7	1,1	32,7	31,2	29,2	26,7	23,9	17,2	9
U 3S-90/4	U 3S-90/4 T	0,9	0,66	0,83	0,8	3,6	1,7	44,3	42,8	40	36,4	33,2	24,5	13,9
U 3S-100/5	U 3S-100/5 T	1	0,75	0,99	0,92	4,4	1,7	55,3	53,5	50,3	46,5	42,1	31,6	17,7
U 3S-120/6	U 3S-120/6 T	1,2	0,9	1,11	1,11	5,1	2,5	66,6	64,4	60,8	56	50,7	38,1	22,4
U 3S-150/7	U 3S-150/7 T	1,5	1,1	1,38	1,31	6,4	2,7	80,1	77,7	74,2	69,1	63,3	48,8	30

5 S

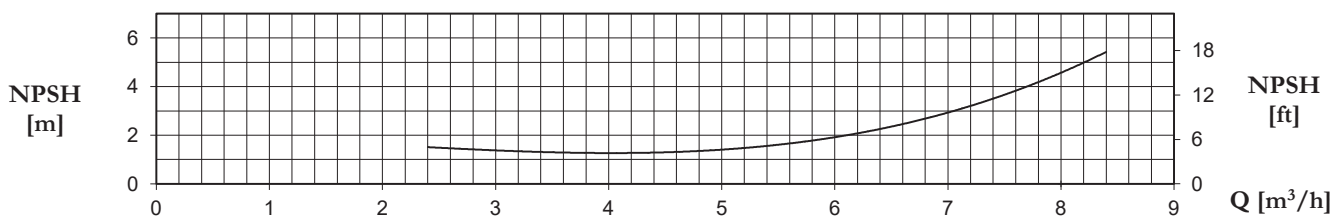
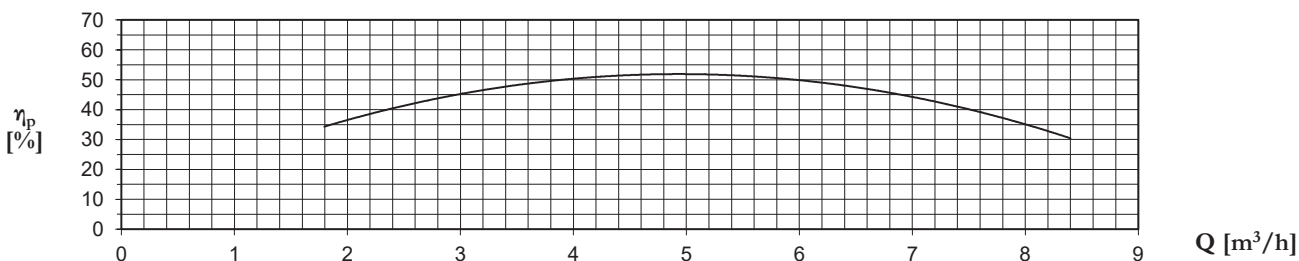
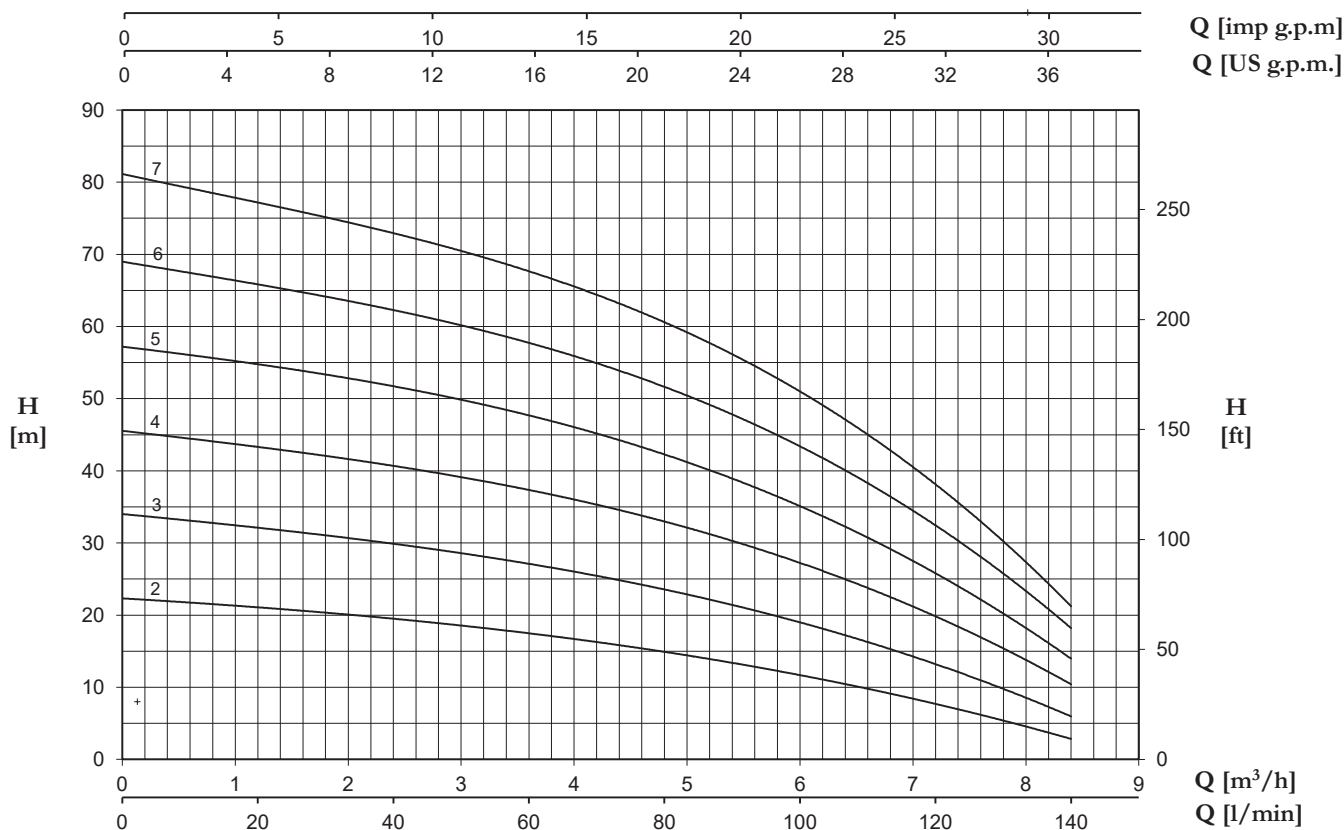

TYPE/TYP		P2		P1 (kW)		PROUD		Q (m³/h - l/min)							
1~	3~					1~	3~	0	1,8	2,4	3,6	4,8	6	7,2	8,4
		(HP)	(kW)	1~	3~	1x230 V 50 Hz	3x400 V 50 Hz	H (m)							
U 5S-70/2	U 5S-70/2 T	0,7	0,51	0,6	0,58	2,6	1,1	22,3	20,4	19,5	17,5	14,8	11,7	7,8	2,8
U 5S-80/3	U 5S-80/3 T	0,8	0,6	0,8	0,75	3,8	1,4	34	31,1	29,9	27	23,6	19,1	13,1	6
U 5S-120/4	U 5S-120/4 T	1,2	0,9	1,09	1,08	4,9	2,4	45,5	42,2	40,7	37,2	32,9	27,4	19,8	10,4
U 5S-150/5	U 5S-150/5 T	1,5	1,1	1,39	1,31	6,5	2,7	57,2	53,4	51,7	47,6	42,3	35,2	25,7	14
U 5S-180/6	U 5S-180/6 T	1,8	1,3	1,63	1,55	7,3	3	68,9	64,4	62,3	57,5	51,5	43,5	32,6	18,1
U 5S-200/7	U 5S-200/7 T	2	1,5	1,94	1,77	8,7	3,3	81	75,5	73	67,4	60,3	51	38,6	21

# 7 S

ULTRA S

MULTIGIRANTI / MULTISTAGE / MULTICELLULARES / VÍCESTUPNOVÁ ODSTŘEDIVÁ

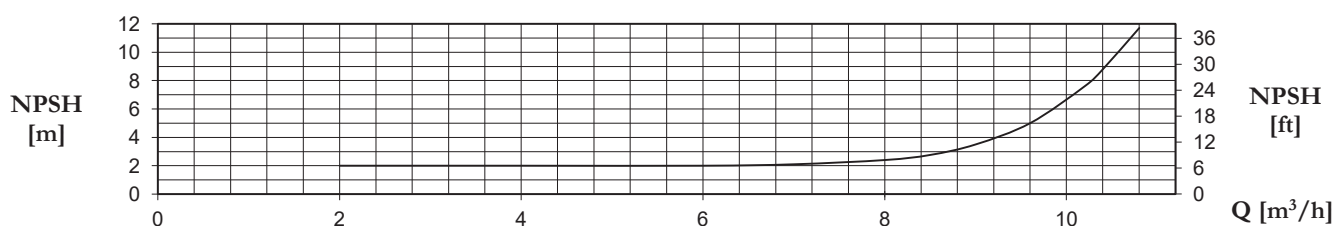
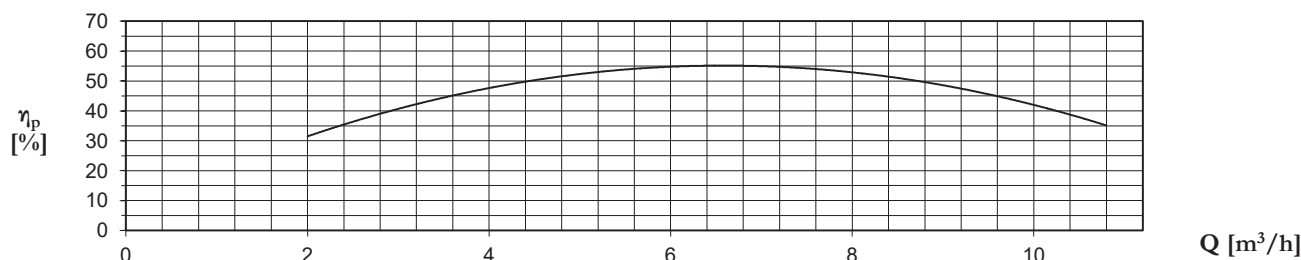
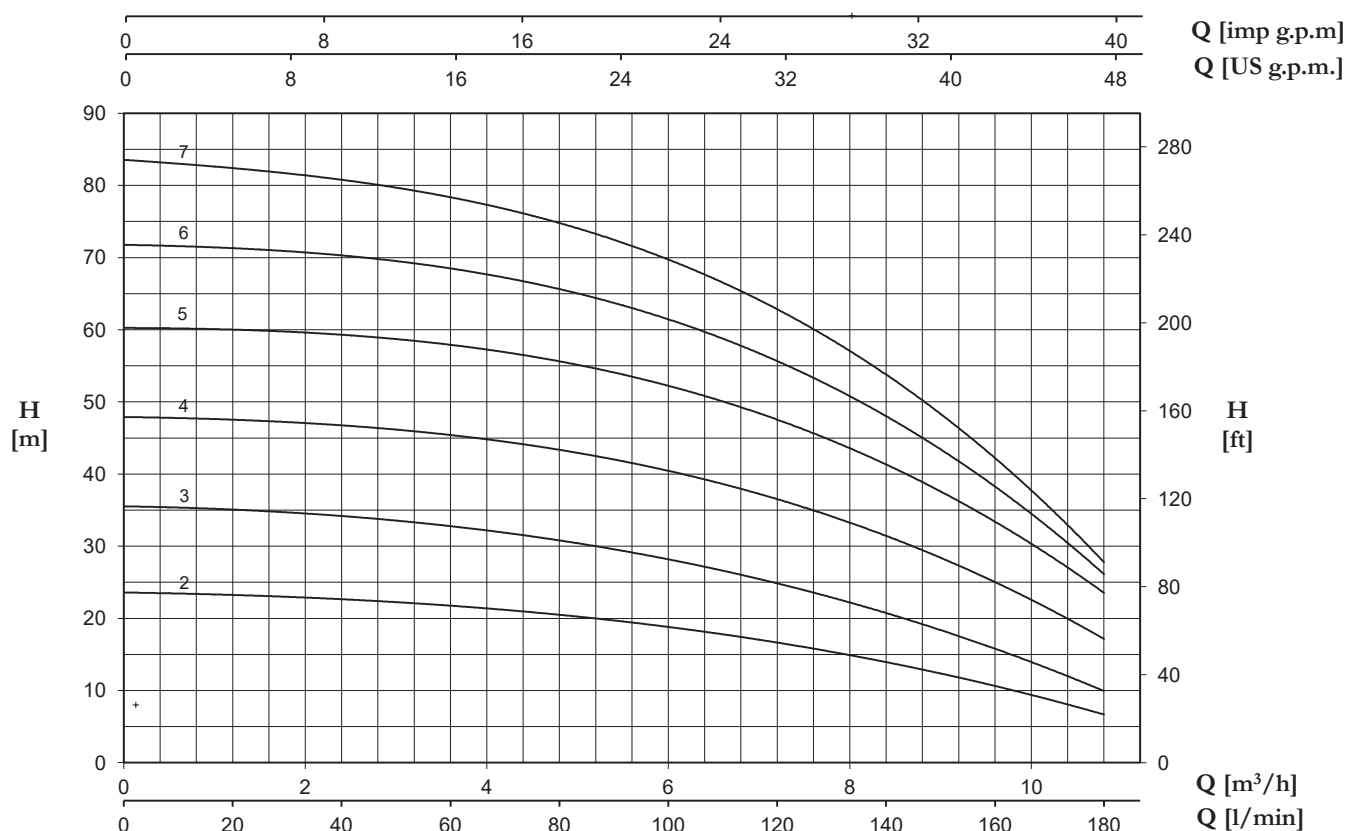

TYPE/TYP		P2		P1 (kW)		PROUD		Q (m³/h - l/min)								
1~	3~					1~	3~	0	2,4	3,6	4,8	6	7,2	8,4	9,6	10,8
		(HP)	(kW)	1~	3~	1x230 V 50 Hz	3x400 V 50 Hz	0	40	60	80	100	120	140	160	180
								H (m)								
U 7S-100/2	U 7S100/2 T	1	0,75	0,91	0,84	4,1	1,6	23,6	22,6	21,8	20,5	18,8	16,7	13,9	10,6	6,7
U 7S-120/3	U 7S-120/3 T	1,2	0,9	1,23	1,22	5,6	2,5	35,6	33,9	32,8	31,2	28,1	24,7	20,8	15,7	10
U 7S-180/4	U 7S-180/4 T	1,8	1,3	1,69	1,62	7,7	3,1	48	46,3	45,7	43,6	40,4	36,4	31,4	25	17,2
U 7S-250/5	U 7S-250/5 T	2,5	1,85	2,19	2,05	10,2	4,1	60,3	59	58,2	55,7	52,2	47,4	41,3	33,5	22
U 7S-300/6	U 7S-300/6 T	3	2,2	2,53	2,44	11,4	4,8	72,5	70,5	69,2	66	61,5	55,7	47,8	37,8	24,7
-	U 7S-350/7 T	3,5	2,57	-	2,84	-	5,1	83,5	80,7	78,8	74,7	69,4	62,6	53,9	42,7	27,5

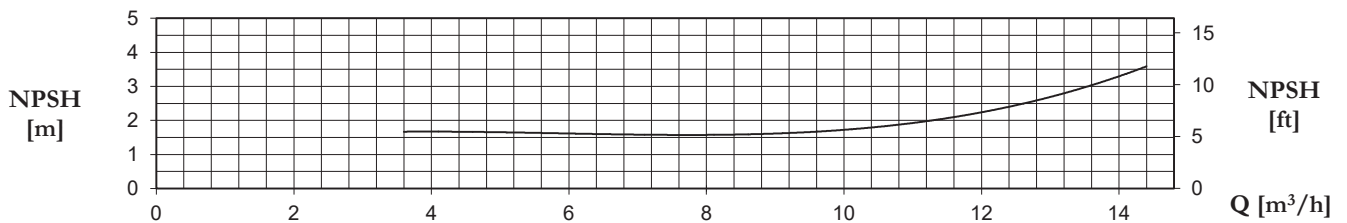
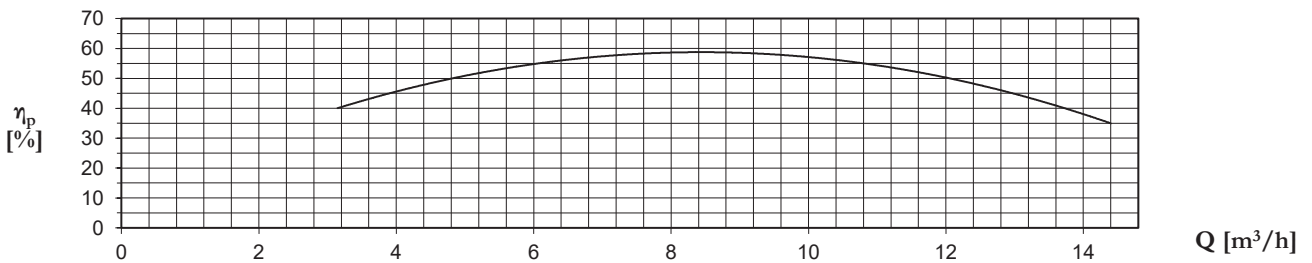
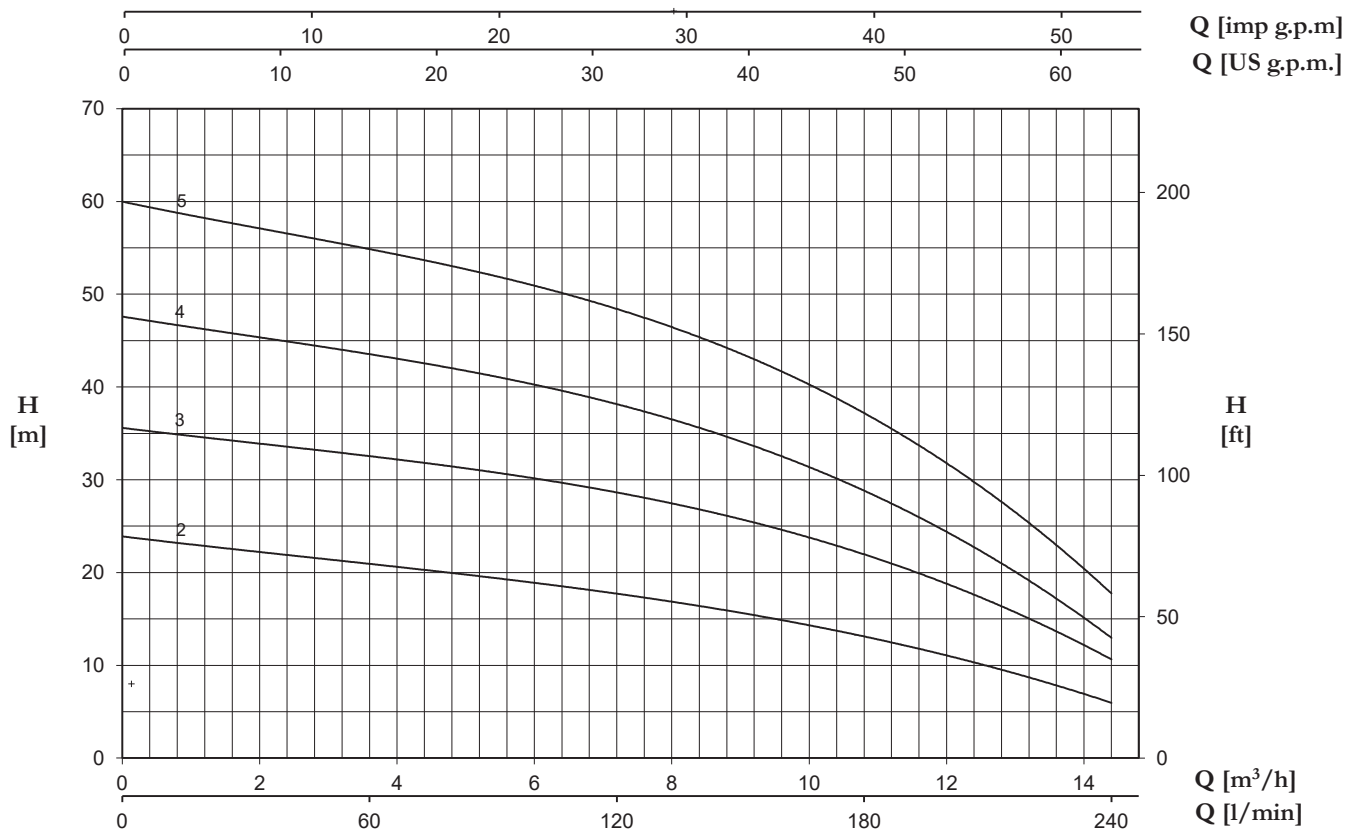

TYPE/TYP		P2		P1 (kW)		PROUD		Q (m <sup>3</sup> /h - l/min)										
1~	3~					1~	3~	0	3,6	4,8	6	7,2	8,4	9,6	10,8	12	13,2	14,4
						50 Hz		0	60	80	100	120	140	160	180	200	220	240
						H (m)												
U 9S-100/2	U 9S-100/2 T	1	0,75	0,99	0,95	4,5	1,6	23,9	20,9	20	18,8	17,7	16,5	15	13	11	8,7	6
U 9S-150/3	U 9S-150/3 T	1,5	1,1	1,47	1,4	6,8	2,8	35,6	32,5	31,5	30	28,7	26,9	24,6	22	18,7	15	10,7
U 9S-200/4	U 9S-200/4 T	2	1,5	1,88	1,77	8,4	3,3	47,6	43,5	42,1	40,1	38,1	35,7	32,7	28,9	24,2	19	13,1
U 9S-250/5	U 9S-250/5 T	2,5	1,85	2,36	2,23	10,8	4,3	60	54,8	53	51	48,2	45,4	42	37,3	31,6	25	18

# 18 S

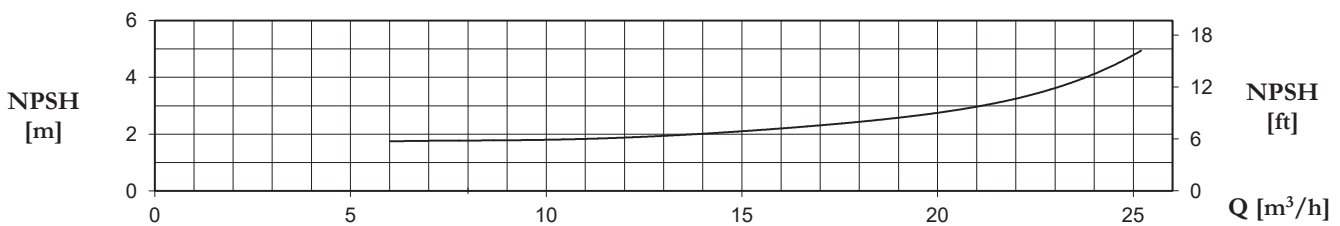
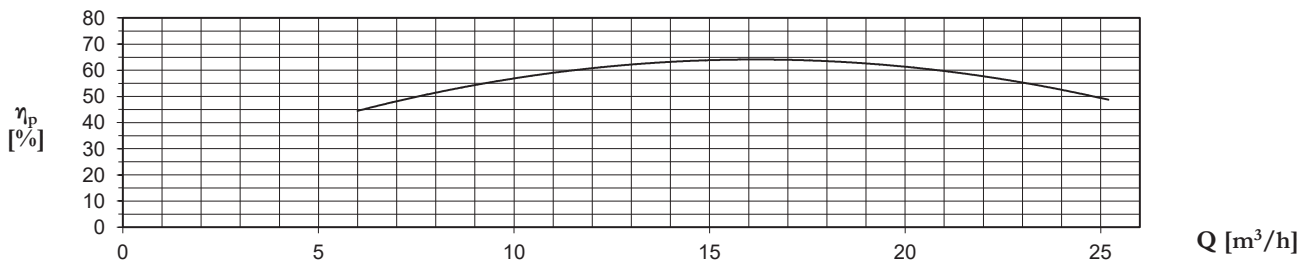
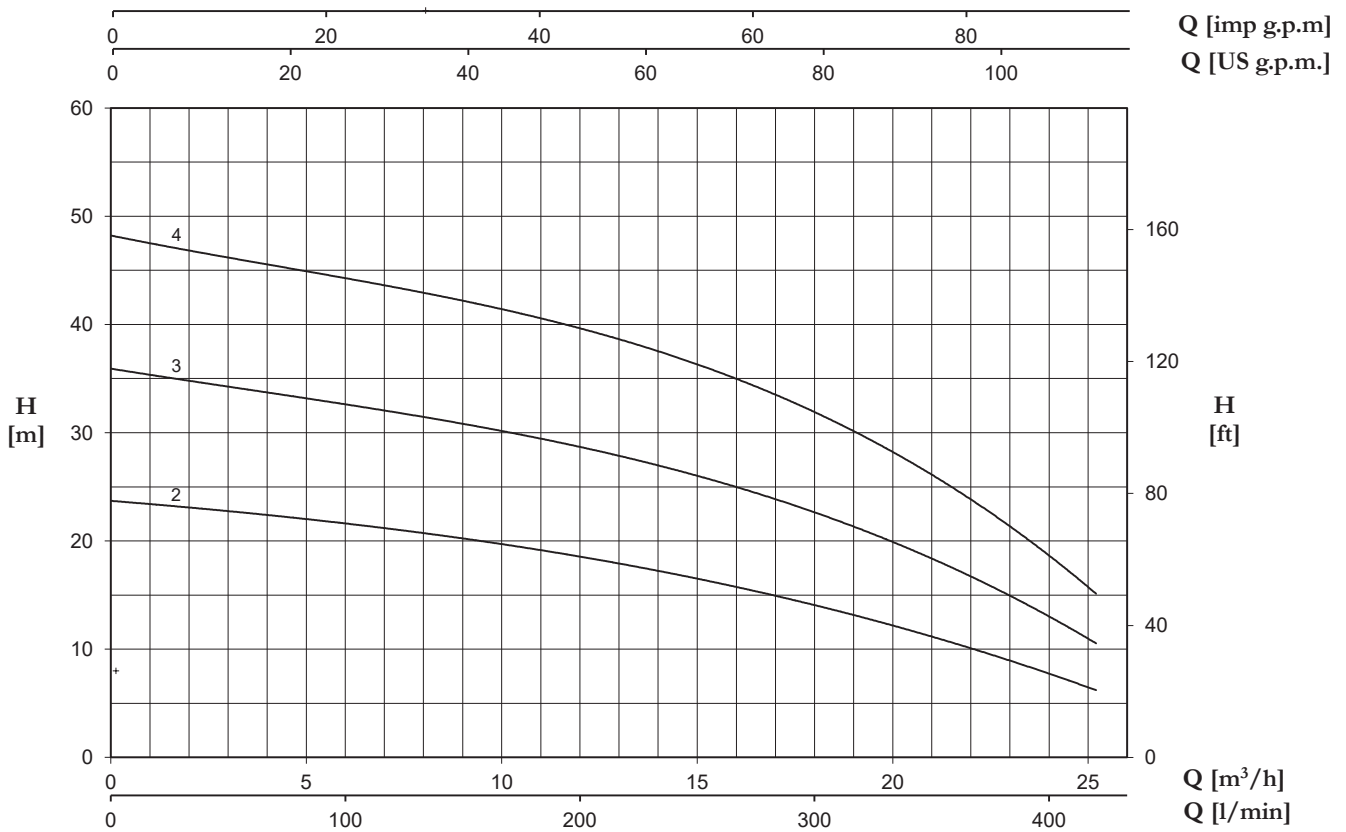

TYPE/TYP	P2		P1 (kW)	PROUD 3~	Q (m³/h - l/min)																	
					H (m)																	
					0	6	7,2	8,4	9,6	10,8	12	13,2	14,4	15,6	16,8	18	19,2	20,4	21,6	22,8	24	25,2
3~	(HP)	(kW)	3~	3x400 V 50 Hz	0	100	120	140	160	180	200	220	240	260	280	300	320	340	360	380	400	420
U 18S-180/2 T	1,8	1,3	1,59	3	23,7	21,7	21,1	20,4	20	19,3	18,5	17,7	16,9	16	15,2	14,3	13,1	11,8	10,3	9,1	7,6	6,4
U 18S-250/3 T	2,5	1,85	2,29	4,4	35,7	33,1	32,3	31,3	30,4	29,4	28,4	27,4	26,3	25,1	24	22,8	21,4	19,6	17,8	15,4	12,9	10,2
U 18S-400/4 T	4	3	3,11	5,7	47,9	45	44	42,8	41,7	40,5	39,1	37,8	36,6	35,2	33,9	32,2	30,2	28	25,1	22,1	18,1	14,9

**ULTRA S**

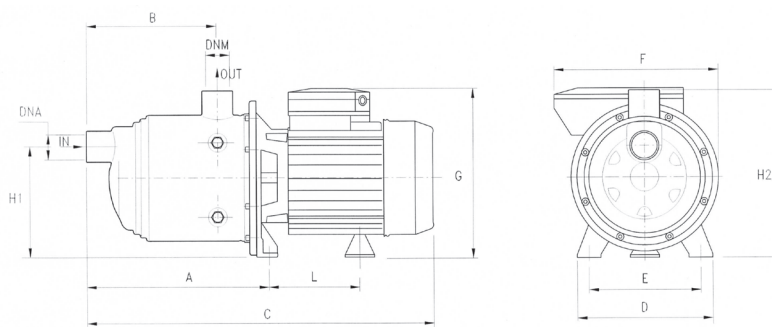

TYPE/TYP	DIMENSIONS/ROZMĚRY (mm)										Kg	DNA	DNM
	A	B	C	D	E	F	G	L	H1	H2			
U 3S-50/2	166.8	103	333	164	140	178	190	93.7	128	192	6.9	1" G	1" G
U 3S-70/3	166.8	103	333	164	140	178	190	93.7	128	192	8.0		
U 3S-90/4	190.8	127	357	164	140	178	190	93.7	128	192	9.4		
U 3S-100/5	214.8	151	404	164	140	178	203	104.7	128	192	12.0		
U 3S-120/6	238.8	175	428	164	140	178	203	104.7	128	192	12.7		
U 3S-150/7	262.8	199	483	164	140	201	211	128.2	134	198	16.1		
U 5S-70/2	166.8	103	333	164	140	178	195	93.7	128	192	7.7		
U 5S-80/3	166.8	103	357	164	140	178	203	93.7	128	192	10.3		
U 5S-120/4	190.8	127	380	164	140	178	203	104.7	128	192	12.1		
U 5S-150/5	214.8	151	436	164	140	201	211	128.2	134	198	14.9		
U 5S-180/6	238.8	175	459	164	140	201	211	128.2	134	198	16		
U 5S-200/7	262.8	199	483	164	140	201	211	128.2	134	198	18.1		

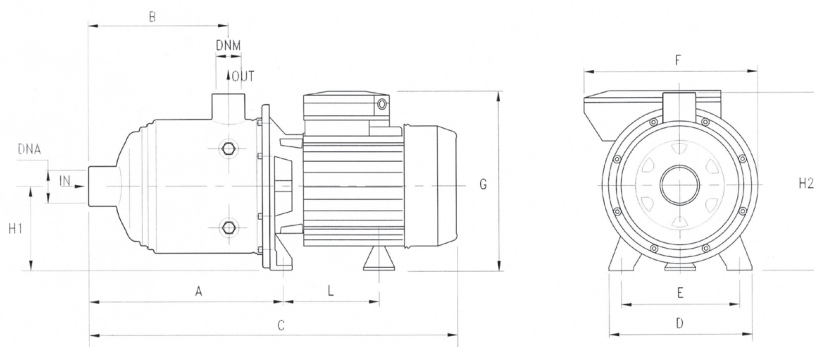

TYPE/TYP	DIMENSIONS/ROZMĚRY (mm)										Kg	DNA	DNM
	A	B	C	D	E	F	G	L	H1	H2			
U 7S-100/2	166.8	103	356	164	140	178	203	104.7	103	192	10.6	1 1/4 G	1" G
U 7S-120/3	166.8	103	356	164	140	178	203	104.7	92	192	11.6		
U 7S-180/4	190.8	127	411	164	140	201	211	128.2	98	198	15.0		
U 7S-250/5	214.8	151	436	164	140	201	211	128.2	98	198	17.3		
U 7S-300/6	238.8	175	M 503	164	140	201	M 229	M 148.2	M 103	M 203	20.0		
			T 459				T 211	T 128.2	T 98	T 198			
U 7S-350/7	262.8	199	527	164	140	201	229	148.2	92	203	20.7		
U 9S-100/2	185.8	118	375	164	140	178	203	104.7	98	192	10.8	1 1/2 G	1 1/4 G
U 9S-150/3	185.8	118	375	164	140	201	211	128.2	98	198	14.2		
U 9S-200/4	215.8	148	436	164	140	201	211	128.2	98	198	16.8		
U 9S-250/5	245.8	178	464	164	140	201	211	128.2	98	198	17.7		
U 18S-180/2 T	201	141	432	164	140	201	211	128.2	98	198	14.0	2" G	1 1/2 G
U 18S-250/3 T	238.5	141	432	164	140	201	211	128.2	98	198	15.8		
U 18S-400/4 T	276	178.5	514	164	140	201	229	148.2	103	203	22.6		

TYPE	TRUCK		CONTAINER	
	PALLET (cm)	N° pumps	PALLET (cm)	N° pumps
U 3S-50/2-90/4	80X120X150	84	80X120X175	96
U 3S-100/5-120/6	85X110X160	70	85X110X185	80
U 3S-150/7	80X120X150	42	80X120X175	49
U 5S-70/2	80X120X150	84	80X120X175	96
U 5S-80/3-120/4	85X110X160	70	85X110X185	80
U 5S-150/5	90X110X150	54	90X110X170	63
U 5S-180/6-200/7	80X120X150	42	80X120X175	49
U 7S-100/2-120/3	85X110X160	70	85X110X185	80
U 7S-180/4-250/5	90X110X150	54	90X110X170	63
U 7S-300/6 T	80X120X150	42	80X120X175	49
U 7S-300/6 M-350/7 T	80X120X145	35	80X120X170	42
U 9S-100/2	85X110X160	70	85X110X185	80
U 9S-150/3-200/4	90X110X150	54	90X110X170	63
U 9S-250/5	80X120X150	42	80X120X175	49
U 18S-180/2-250/3	90X110X150	54	90X110X170	63
U 18S-400/4	80X120X145	35	80X120X170	42